

---

**NEWALL**

NEWALL MEASUREMENT SYSTEMS LTD

---

DP8

Digital Readout Display

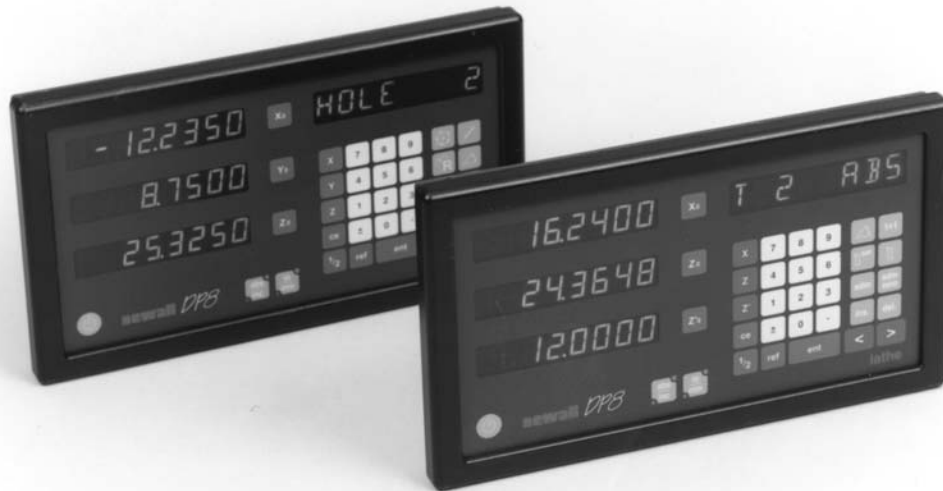

# CONTENTS

## 1.0 Introduction

- 1.1 EMC and Low Voltage Compliance
- 1.2 Technical Specifications

## 2.0 Installation

- 2.1 Mounting
- 2.2 Power Supply
- 2.3 Connections
- 2.4 Switching On

## 3.0 User Instructions

- 3.1 Options
- 3.2 Using the Keypad

## 4.0 Set-Up

- 4.1 Set-Up Introduction
- 4.2 Set-Up Defaults
- 4.3 Set-Up Menu

## 5.0 Standard Functions

- 5.1 Absolute/Incremental
  - 5.1.1 Using Incremental
  - 5.1.2 Using Absolute
  - 5.1.3 Establishing a datum
- 5.2 Centre Find
- 5.3 Digifind (Ref)
  - 5.3.1 Using a machine marker or workpiece marker
  - 5.3.2 Find Absolute Zero

## 5.4 Sub Datums (SDM)

- 5.4.1 Method 1 (Teach mode)
- 5.4.2 Method 2 (Manual Mode)
- 5.4.3 Job Number
- 5.4.4 Editing Sub Datums and Job Number

## 5.5 Inch/mm

## 5.6 Datahold (Display Off)

## 5.7 Zero Approach

## 6.0 Mill Functions

- 6.1 Arc
- 6.2 PCD (Bolt Hole Circle)
- 6.3 Line Hole
- 6.4 Polar Co-ordinates

## 7.0 Lathe Functions

- 7.1 Tool Offsets
- 7.2 Taper
- 7.3 Summing
- 7.4 Vectoring

## 8.0 Auxiliary Output Option

- 8.1 Position Pulse Output
- 8.2 Remote Zero and Enter Inputs

## 9.0 Troubleshooting

## 10.0 Cleaning

# 1.0 INTRODUCTION

## 1.1 EMC and Low Voltage Compliance

The DP8 Digital Readout conforms to the relevant European standards for electromagnetic compatibility and low voltage directive as detailed below.

BS EN 50081-2: Electromagnetic compatibility.  
Generic Emission Standard - Industrial Environment

BS EN 50082-2: Electromagnetic compatibility.  
Generic Immunity Standard - Industrial Environment.

BS EN 61010-1: Safety requirements for electrical equipment for  
measurement, control and laboratory use.



Certificate No FM36096



## 1.2 Technical Specifications

<b>Construction:</b>	Two part system - display/keyboard separate from DSU/Inputs	
<b>Dimension</b>	<b>Display/Keyboard</b>	<b>DSU</b>
<b>Height:</b>	170mm (6.7in)	130mm (5.1in)
<b>Width:</b>	295mm (11.6in)	185mm (7.3in)
<b>Depth:</b>	30mm (1.2in)	60mm (2.4in)
<b>Weight:</b>	2.1kg (4.6lbs)	1.7kg (3.7lbs)
<b>Operating Voltage:</b>	115 or 230V (switch selection)	
<b>Supply Voltage Fluctuation:</b>	Not to exceed +/-15% of the operating voltage	
<b>Supply Frequency:</b>	50 to 60 Hz	
<b>Maximum Power Consumption:</b>	26VA	
<b>Operating Temperature:</b>	0 to 45°C (32°F to 113°F)	
<b>Storage Temperature:</b>	-20 to 60°C (-4°F to 140°F)	
<b>Inputs:</b>	Dependant on model, two or three Spherosyn/Microsyn transducers	
<b>Resolution:</b>		
<b>Spherosyn/Microsyn 10</b>	5µm (0.0002in) / 10µm (0.0005in) / 20µm (0.001in) / 50µm (0.002in)	
<b>Microsyn 5</b>	1µm (0.00005in) / 2µm(0.0001in) / 5µm (0.0002in) / 10µm (0.0005in)	
<b>Environmental Conditions:</b>	Indoor Use, IP20 (IEC 529)	
	Relative humidity - maximum 80% for temperatures up to 31°C (87.8°F), decreasing linearly to 33% at 45°C (113°F).	
	Transient overvoltage according to INSTALLATION CATEGORY II of IEC664	
	POLLUTION DEGREE 2 in accordance with IEC664	

NEWALL MEASUREMENT SYSTEMS LIMITED RESERVES THE RIGHT TO CHANGE SPECIFICATION  
WITHOUT NOTICE

## 2.0 INSTALLATION

### 2.1 Mounting

Select the location of the DP8 with due regard of safety and ease of operation. Keep it clear of moving parts and coolant spray. Ensure that the natural ventilation around the digital sending unit (DSU) is not restricted.

To ensure correct operation of the DP8, it is recommended that the digital sending unit (DSU) is grounded to the machine from the equipotential terminal. A ground strap is provided in the fitting kit. The strap should be cut to a suitable length once the DSU had been fixed to the machine. A terminal is provided for crimping to the ground strap. This operation should be conducted by a suitably qualified engineer. The machine must also be grounded to a good earth point.

The DP8 can be mounted in two basic ways as shown in Figure 2.1

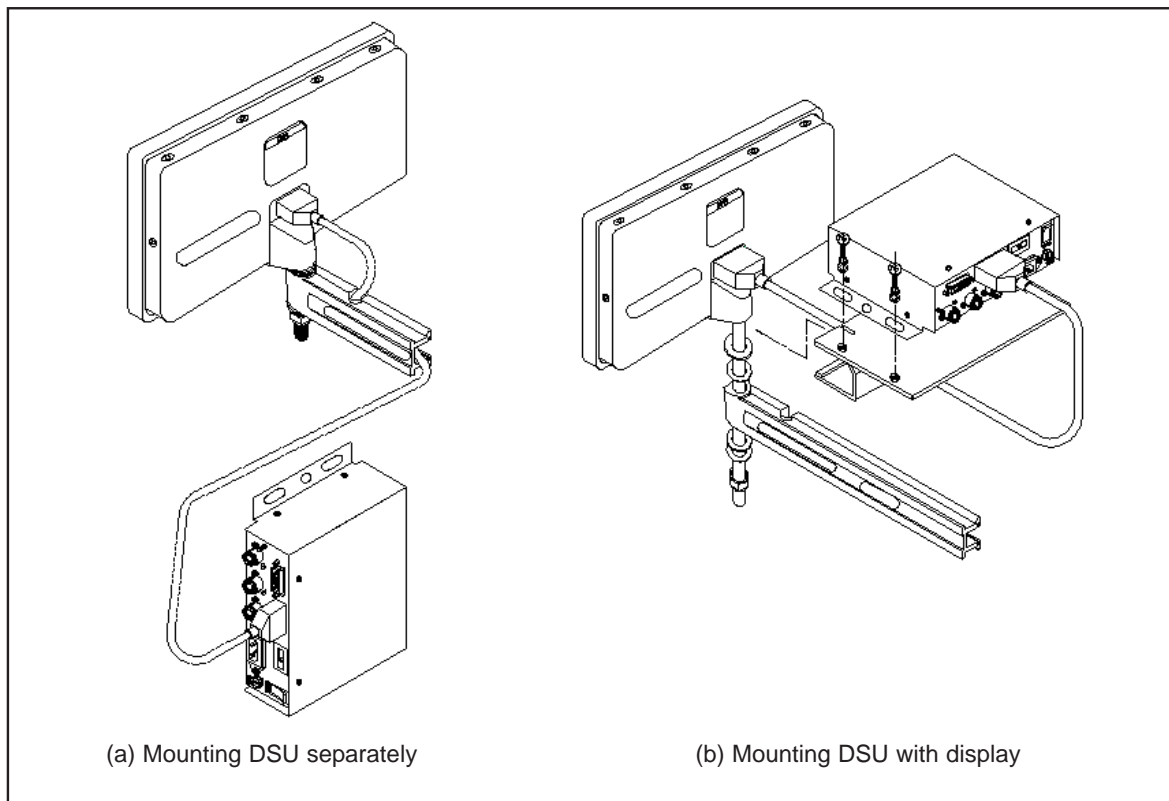

*Figure 2.1 - Mounting Procedures*

#### 2.1.1 Display and digital sending unit (DSU) mounted separately (Figure 2.1a)

The keypad/display unit incorporates an M10 tapped hole in the rear of the unit. The M10 hole can be used to mount the display in any of the standard methods as shown in Figure 2.2. The M10 stud mount is provided as standard. The swivel mount assembly (Part No. 294-37740), the DP8 mounting arm (Part No 294-40050) and the DSU mounting assembly (Part No 600-65590) are all optional items as detailed on the price list.

back view)

The DSU is normally mounted on a vertical face on the rear of the machine. The DSU facilitates the fixing in 2, 3 or 4 point location. For metric applications drill and tap an M6 hole and locate the DSU by inserting one of the M6 bolts provided. Ensure the DSU is level, mark the next location and drill and tap the second hole. Repeat this process for the required number of fixing locations. For those customers requiring imperial (Inch) fittings, repeat the above process substituting 1/4 inch UNC tapped hole and bolts.

**Note:** The fitting kit includes both the metric and imperial fittings. The metric fittings are zinc coated whereas the imperial fittings are black

The DSU is connected to the keypad/display via a 3.5 metre 9 pin "D" type cable. The cable can only be connected in one direction. Once connected, secure the cable at both ends using the slotted locking screws.

Please note, as shown in Figure 2.1, the transducer and mains leads should be positioned underneath the DSU to avoid any ingress of coolant.

## 2.1.2 Display and data sending unit (DSU) mounted together (Figure 2.1b)

An optional bracket (Part No 600-65590) is available to facilitate the mounting of the DSU directly to the keypad/display. This assembly can be mounted using the standard M10 stud, the swivel mount assembly (Part No 294-37740), the DP8 mounting arm (Part No 294-40050) . The last three items are optional and are detailed on the price list.

The DSU is mounted to the optional bracket by four M6 bolts. These bolts are provided with the bracket assembly.

The bracket kit includes a 300mm 9 pin "D" type cable. This cable is to be used to connect the DSU to the keypad/display. The 3.5 metre cable is not needed in this configuration. The cable can only be connected in one direction. Once the sockets are located in the DSU and the keypad/display secure the slotted locking screws.

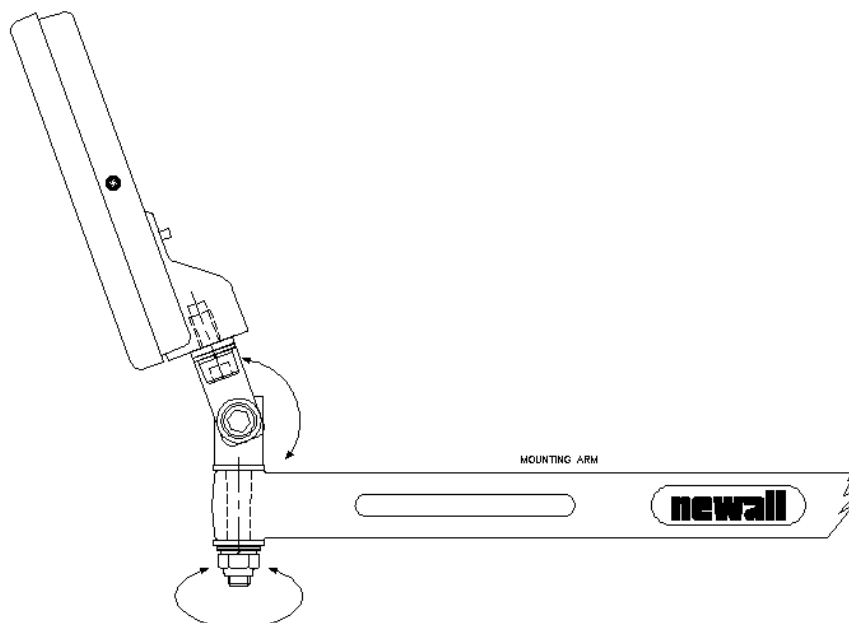

Figure 2.2 - M10, Swivel Mount and Arm .

## 2.2 Power Supply !

BEFORE CONNECTING THE ELECTRICAL SUPPLY TO THE DIGITAL SENDING UNIT (DSU), CHECK THAT THE VOLTAGE SELECTOR SWITCH IS CORRECTLY SET. Figure 2.3 shows the position of this switch.

The mains supply is connected through a detachable supply cord. The counter is supplied with a cord with a right-angle connector. If another supply cord is used, it must have fitted a IEC320, 10A, EARTHED mains connector with a cord rated for at least 10A.

The PROTECTIVE EARTH CIRCUIT of the mains supply MUST BE CONNECTED to the protective earth terminal of the DSU through the supply cord.

The supply cord should be secured with cable ties to ensure that it cannot drop into a hazardous position, ie. the floor or coolant tray, when disconnected from the DSU.

The supply cord must be routed away from moving parts, swarf, coolant or sources of heat.

If a mains plug is not already fitted to the supply cord or is of the wrong type, then a suitable EARTHED plug should be used which complies with the relevant specifications for plugs and socket-outlets.

The mains supply fuse is a 20x5mm, type T0.5A, 250V. It is not to be replaced by the operator. If the fuse blows it is a possible indication of some significant problem with the power source. Check the supply and wiring carefully. If the fuse is replaced, the DSU must first be disconnected from the supply by the removal of the IEC socket from the inlet. This connector is the primary disconnect device for the equipment and must be accessible at all times. Do not position the equipment so that it is difficult to operate the disconnect device.

**NOTE:** If the equipment is used in a manner not specified by the manufacturer, the protection provided by the equipment may be impaired.

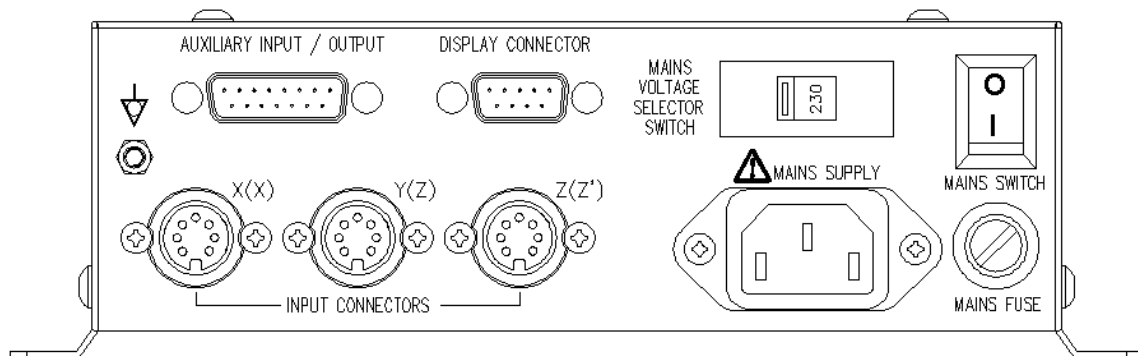

Equipotential terminal for grounding the DSU to the machine. Refer to section 2.1.



Caution. Refer to section 2.2 before connection to the mains supply.

*Figure 2.3 - Connection diagram for the Digital Sending Unit (DSU)*

## 2.3 Transducer Connection

Figure 2.3 shows the connection sockets on the DSU. The DP8 is designed for use with Newall's Spherosyn and Microsyn transducers only. The transducers are connected to the DSU with Bleecon type connectors. These connectors have a sliding sleeve that locks the connectors to their sockets.

Switch off the DSU before connecting or disconnecting the transducers. To fit the connectors into the appropriate socket on the DSU, first align the connector and then push firmly in place. You should hear a click confirming that the locking sleeve has engaged. To remove the connector, pull back on the connector sleeve to disengage the locking mechanism.

The transducers and the display/keyboard are connected to the DSU at a separated extra low voltage (SELV) level. Any additional interconnections must also be at SELV level.



## 2.4 Switching On

The mains supply switch for the DP8 is mounted on the side of the DSU as shown in Figure 2.3.

When you switch on the DP8, the unit will automatically go through a brief self diagnostic routine.

During this routine, the name DP8 will be shown, then the software version number will be displayed and all segments of the displays will be lit.

After this routine, the unit will display measurements and is ready for use.

The DP8 can be switched off via the mains switch on the DSU. Alternatively, the keypad/display can be switched off by pressing the  key. Please note that the DSU remains under power when the  key is pressed.

### CONVENTIONS USED IN THIS MANUAL

The direction of travel of an axis refers to the travel of the tool relative to the workpiece.

Keys on the keypad are signified in bold print, such as [ **ENT** ] for the enter key.

# 3.0 USER INSTRUCTIONS

## 3.1 Options





The DP8 is available in three models, the DP8 Mill, DP8 Lathe and the DP8 EDM. Each DP8 model is available with an optional auxiliary port. The auxiliary port is used for (i) a remote zero pendant (part number 600-17690) and (ii) for positional output data





Models	2 Axes	3 Axes	Additional Features
DP8 Mill	3	3	Bolt Hole Circle (PCD) and Bolt Hole Arc mode, Line Hole (max 999 holes), Arc contouring, Polar co-ordinates, Sub-Datums
DP8 Lathe	3	3	Tool Offsets, 99, Taper calculations, Internal summing, Vectoring, Sub-Datums

## 3.2 Using the keypad

The keys are used as follows

Standard Keys	Purpose
	On/Off (Display only, not DSU)
	Select axis to enter dimension (preset)
	Set the current position for the axis to zero (reset)
	Clear entry values in preset mode
	Enter key to confirm data entry
	Switches between absolute and incremental readings (LED indicates choice of mode)
	Centre find function
	Select the Digifind function
	Switches between inch and millimetre display (LED indicates choice of mode)
	Numeric keypad for data entry
	Selecting the required Sub-Datum number
	Setting the selected Sub-Datum to zero
	Insert / Delete
	Scroll Previous / Scroll Next

Mill Option Keys	Purpose
	For using the Pitch Circle Diameter (PCD) function
	For using the Line Hole function
	For using the ARC function
	For selecting between Cartesian (x,y,z) and Polar (Length+Angle) co-ordinates

Lathe Option Keys	Purpose
	For Taper calculations
	For using Tool Off-Sets
	Setting Tool Off-Sets
	Summing function, vectoring function



DP8 Mill 2 Axes



DP8 Mill 3 Axes



DP8 Lathe 2 Axes



DP8 Lathe 3 Axes

# 4.0 SET-UP

## 4.1 Set-Up Introduction

The DP8 digital readout display is equipped with a Set-Up Routine. The routine enables the operator to change factory settings in order to increase efficiency and productivity. If the factory defaults are suitable, select the NORMAL option at the end of the Routine to restore the factory defaults.

Generally, the entire Set-Up Routine is performed only one time. Changing some parameters in Set-Up may alter datums, SDMs, tool compensations and Digifind.

**DO NOT RUN SET-UP IF YOU ARE NOT PREPARED TO LOSE THIS DATA.**

Set-Up is enabled while the unit is running its initial self-test, just after powering on. Press the [ ON/OFF ] on the face of the display as the self-test is running.

The Set-Up procedure makes use of a menu system. The main menu consists of a list of options that can be customised for your use (See Table 1). You simply press the [ < ] and [ > ] keys to scroll through this list until you reach the option you wish to change. To change the option when selected, press [ ENT ].

To exit the Set-Up routine scroll through to the quit option and press [ ENT ].

If the keypad/display has been switched off by pressing the [ ON/OFF ] key rather than switching off at the mains, it is possible to enter the Set-Up routine by pressing the [ ABS/INC ] key followed by the [ ON/OFF ] key.



**ON/OFF key**



**ABS/INC key**



**ON/OFF key**

This is required to complete the proper sequence as described in text above

## 4.2 Set-Up Defaults

FUNCTION	DESCRIPTION	DEFAULT SETTING	MENU OPTIONS
<b>LANGUAGE</b>	Selects the language to display messages	ENGLISH	English/French/German/Spanish Italian/Danish/Czech
<b>KEY BEEP</b>	Enables the audible beep when keys are pressed on the keypad	ON	On/Off
<b>I/P TYPE</b>	Selects the type of transducer on each axis	SPHEROSYN	Spherosyn/Microsyn 5/Microsyn 10
<b>RAD/DIA</b>	Selects radius or diameter reading for each axis	RAD (DIA - X axis lathe)	Rad/Dia
<b>RESOLUTION</b>	Selects the resolution to be displayed on each axis	5µm	1 / 2 / 5 / 10 / 20 / 50µm
<b>DIRECTION</b>	Changes the direction of count for each axis	1	0 / 1
<b>LIN COMP</b>	Enters a linear error compensation factor	1.000000	Set Axis (Automatic or direct entry)
<b>SDM</b>	Enables the subdatum memory function on the keypad	ON	On/Off
<b>POS OUT</b>	Enables the position pulse output function (Only available when the optional auxiliary port is included)	OFF	Off/X Axis/Y Axis/Z Axis/ All Axes
<b>POS SET</b>	Sets the position that triggers a pulse output (Only available when the optional auxiliary port is included)	ALL ZERO	Posit-1 / Posit-2 / Posit-3 / Reset / Pulse MS
<b>ZERO APPROACH</b>	Enables zero approach function on the keypad	OFF	On/Off
<b>ZERO SET</b>	Enables approach window to be set (Selectable only if zero approach is "on")	0.000	User definable window
<b>NORMAL</b>	Sets factory defaults for the DP8	-	Quit Normal/Default
<b>QUIT</b>	Exits the Set-Up routine and saves settings to memory	-	
<b>MILL OPTIONS</b>			
<b>ARC</b>	Enables the arc contour function on the keypad	ON	On/Off
<b>PCD</b>	Enables the bolt hole circle function on the keypad	ON	On/Off
<b>LINE</b>	Enables line hole function on keypad	ON	On/Off
<b>POLAR</b>	Enables line polar co-ordinate function on the keypad	ON	On/Off
<b>LATHE OPTIONS</b>			
<b>TOOL</b>	Enables tool offset compensation	ON	On/Off
<b>SUMMING</b>	Enables summing of axes on the keypad	OFF	Off/ X+Z' / Z+Z' / Vectedored
<b>TAPER</b>	Enables Taper function on the keypad.	ON	On/Off

Table 1 - Set-Up Defaults

### 4.3 Set-Up Menu

**(a) Set-Up**

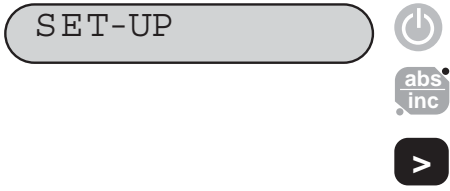

The Set-Up procedure can only be entered by pressing the **[ON/OFF]** during the power on sequence or by turning the display off using **[ON/OFF]** and then pressing **[ABS/INC]** before pressing **[ON/OFF]** again.

When you have entered the Set-Up routine, the letters 'SET-UP' appear in the top axis display.

Press the [ > ] key to move to the next menu option.

**(b) Language**

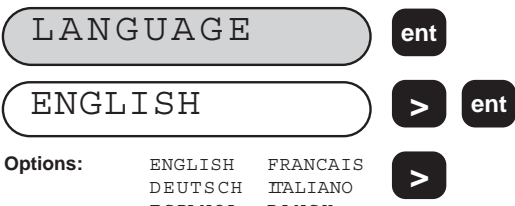

**Options:** ENGLISH FRANCAIS  
DEUTSCH ITALIANO  
ESPANOL DANSK  
CESKY

Press the [ > ] key to move to the next menu option.

*Scroll through the available options using the arrow keys and select the desired language mode with [ENT]*

**(c) Key Beep**

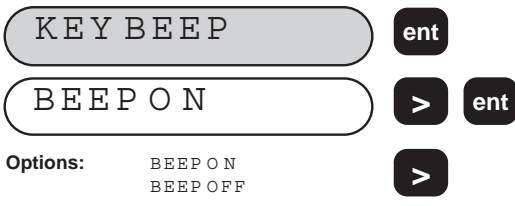

**Options:** BEEP ON  
BEEP OFF

Press the [ > ] key to move to the next menu option.

*Toggle between Beep On and Beep Off using the arrow keys and select desired mode with [ENT]*

**(d) I/P Type**

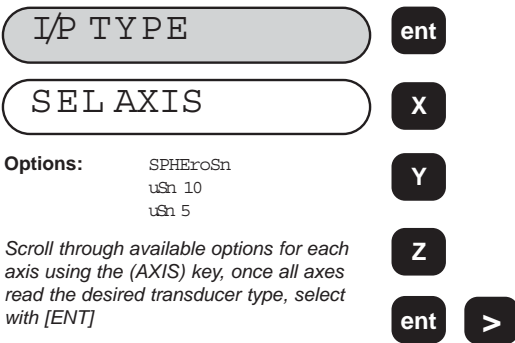

**Options:** SPHERoSyn  
uSn 10  
uSn 5

*Scroll through available options for each axis using the (AXIS) key, once all axes read the desired transducer type, select with [ENT]*

The I/P (Input) Type function allows the operator to specify the type of transducer connected to each axis. The DP8 reads Newall's Spherosyn, Microsyn 10 or Microsyn 5 Transducers.

**IMPORTANT:**  
The input type selected for each axis must match the transducer connected to that axis. The DP8 will give incorrect readings if the I/P Type does not match the transducer installed.

Press the [ > ] key to move to the next menu option.

**(e) Radius / Diameter**

RAD/DIA **ent**

SEL. AXIS **X**

Options: RAD **Y**  
DIA **Z**

Toggle between Radius and Diameter using the (AXIS) keys and select desired mode with [ENT]

**ent** **>** Press the [ > ] key to move to the next menu option.

The Radius/Diameter function allows the operator to display actual (radius) or twice-actual (diameter) measurements for each axis. This function is generally used in turning applications, such as the cross travel on a lathe.

**(f) Resolution**

RESOLUTION **ent**

SEL. AXIS **X**

Options: 0.001mm (0.00005") **Y**  
0.002mm (0.0001") **Z**  
0.005mm (0.0002") **ent**  
0.010mm (0.0005") **>**  
0.020mm (0.002")  
0.050mm (0.005")

Scroll through available options for each axis using the (AXIS) key, once all axes read the desired resolution, select with [ENT]

**ent** **>** The Resolution function allows the operator to determine the resolution for each axis.

**IMPORTANT:**  
The Resolution available for each axis depends upon the I/P (Input) Type established for that axis.

**IMPORTANT:**  
The 0.001 mm (0.00005") resolution is only available in Radius mode.

**ent** **>** Press the [ > ] key to move to the next menu option.

**(g) Direction**

DIRECTION **ent**

SEL. AXIS **X**

Options: 0 **Y**  
1 **Z**

Toggle between 0 and 1 for each axis using the (AXIS) key. When all axes read the desired direction, select with [ENT]

**ent** **>** Press the [ > ] key to move to the next menu option.

Direction allows the operator to change the direction of travel for each axis. Changing the setting will reverse the current direction.

**EXAMPLE:**

If the current setting is 0 and the travel is positive from right to left, changing the setting to 1 will reverse the direction to measure positive from left to right.

**(h) Linear Error Compensation**

LINEAR COMP **ent**

SEL. AXIS **X**

**Y**

**Z**

Select the axis to be compensated using the axis keys

Continued overleaf...

Linear Error Compensation allows the operator to apply a constant correction factor to all measurements displayed. Linear error may occur if the axis of the machine is not running perfectly parallel to the scale (cosine error) or if the machine is moving in an arc (Abbé errors). The causes may be:

1. Machine wear.
2. Deflection of the machine due to weight acting on an overhanging section.
3. Misalignment of the scale due to poor installation.

Z E R O

X<sub>0</sub>

The further away the scale is mounted from the centre line of the workpiece, the greater is the potential for linear error.

Y<sub>0</sub>

Linear Error Compensation is expressed as a multiplier, which is displayed for each axis when LIN COMP is selected. A factor of 1.000000 indicates no compensation.

Z<sub>0</sub>

The compensation factor is:  $\frac{\text{True or standard distance moved}}{\text{Measured distance}}$

S T A N D A R D

2

0

ent

A gauge block, standard bar or laser measurement should be used as the standard against which the displayed movement is compared.

Move the machine to the zero position of the standard against which the axis is being compared and zero the axis with the zero key. Move the machine a known distance as determined by the standard and enter that value.

The new compensation factor is automatically calculated and displayed.

**IMPORTANT:**  
All measurements will be adjusted according to the compensation factor entered for each axis. To disable the adjustment, enter a Linear Error Compensation factor of one (1.000000).

ENT. COMP

>

1

.

0

0

5

Alternatively, the factor may be directly entered. When (ZERO) is displayed, use the arrow keys to switch to (ENT COMP)

ent

Load the required factor.

>

Press the [ > ] key to move to the next menu option.

Use this method to cancel a Linear Error Compensation factor. Enter a factor of 1.000000. Press (ENT) to accept.

**(i) SDM (Sub Datum Memory / Stored Dimension Memory)**

S D M

ent

SDM (Sub Datum Memory or Stored Dimension Memory) ON enables the [SDM] function key on the keypad. If SDM OFF is set, the function key on the keypad is disabled.

S D M O N

>

ent

SDM is explained further in the Sub Datums Section, See Section 5.4 of this manual.

Options:    O N  
              O F F

>

Press the [ > ] key to move to the next menu option.

Toggle between (SDM ON) and (SDM OFF) using the arrow keys and select desired mode with (ENT).

**(j) Arc Contouring (DP8 MILL VERSION ONLY)**

A R C

ent

Setting ARC (Arc Contouring) ON enables the [ ARC ] key on the keypad. If ARC OFF is set, the [ ARC ] function on the keypad is disabled.

A R C O N

>

ent

ARC is explained further in the DP8 Mill Section, See Section 6.0 of this manual.

Options:    A R C O N  
              A R C O F F

>

Press the [ > ] key to move to the next menu option.

Toggle between (ARC ON) and (ARC OFF) using the arrow keys and select desired mode with (ENT).

**(k) PCD / Bolt Hole Circle (DP8 MILL VERSION ONLY)**

PCD **ent**

PCD ON **>** **ent**

Options: PCD ON  
PCD OFF **>**

*Toggle between (PCD ON) and (PCD OFF) using the arrow keys and select desired mode with (ENT).*

Setting PCD (Bolt Hole Circle) ON enables the **[PCD]** function key on the keypad. If PCD OFF is set, the **[PCD]** function on the keypad is disabled.

PCD is explained further in the DP8 Mill Section See Section 6.0 of this manual.

Press the **[ > ]** key to move to the next menu option.

**(l) Line Hole Tool (DP8 MILL VERSION ONLY)**

LINE **ent**

LINE ON **>** **ent**

Options: LINE ON  
LINE OFF **>**

*Toggle between (LINE ON) and (LINE OFF) using the arrow keys and select desired mode with (ENT).*

Setting LINE (Line Hole Tool) ON enables the **[LINE]** key on the keypad. If LINE OFF is set, the **[LINE]** function on the keypad is disabled.

Line Hole is explained further in the DP8 Mill Section, See Section 6.0 of this manual.

Press the **[ > ]** key to move to the next menu option.

**(m) Polar Co-ordinates (DP8 MILL VERSION ONLY)**

POLAR **ent**

POLAR ON **>** **ent**

Options: POLAR ON  
POLAR OFF **>**

*Toggle between (POLAR ON) and (POLAR OFF) using the arrow keys and select desired mode with (ENT).*

Setting POLAR (Polar Co-ordinates) ON enables the **[ POLAR ]** key on the keypad. If OFF is set, the **[POLAR]** function on the keypad is disabled.

Polar Co-ordinates are explained further in the DP8 Mill Section, See Section 6.0 of this manual.

Press the **[ > ]** key to move to the next menu option.

**(n) Tool Offset Compensation (DP8 LATHE VERSION ONLY)**

TOOL **ent**

TOOL ON **>** **ent**

Options: TOOL ON  
TOOL OFF **>**

*Toggle between (TOOL ON) and (TOOL OFF) using the arrow keys and select desired mode with (ENT).*

Setting TOOL (Tool Offsets) ON enables the **TOOL** keys on the keypad. If TOOL OFF is set, the **[TOOL]** function on the keypad is disabled.

Tool Offsets are explained further in the DP8 Lathe Section, See Section 7.0 of this manual.

Press the **[ > ]** key to move to the next menu option.

**(o) Summing (DP8 3 AXES LATHE VERSION ONLY)**

SUMMING **ent**

Setting a summing option enables the **[SUMMING]** key **[ 1+1 ]** on the keypad. If SUMMING OFF is set, the **[SUMMING]** function on the keypad is disabled.

VECTORED **>** **ent**

The Summing function is explained further in the DP8 Lathe Section (See Section 7.0) of this manual.

Options: X + Z<sup>i</sup>  
Z + Z<sup>i</sup>  
VECTORED  
OFF **>**

Press the **[ > ]** key to move to the next menu option.

*Toggle between the options using the arrow keys and select desired mode with (ENT).*

**(p) Taper (DP8 LATHE VERSION ONLY)**

TAPER **ent**

Setting TAPER ON enables the TAPER key on the keypad. If TAPER OFF is set, the TAPER function on the keypad is disabled.

TAPER ON **>** **ent**

The Taper function is explained further in the DP8 Lathe Section (See Section 7.0) of this manual.

Options: TAPER ON  
TAPER OFF **>**

Press the **[ > ]** key to move to the next menu option.

*Toggle between (TAPER ON) and (TAPER OFF) using the arrow keys and select desired mode with (ENT).*

**(q) Zero Approach**

ZERO APP **ent**

Zero approach function can be set ON or OFF.

ZERO ON **>** **ent**

When Zero Approach is ON, the leftmost character of the axis display flashes when the position is within a defined envelope. The flash rate increases as zero is approached.

Options: ZERO ON  
ZERO OFF **>**

Press the **[ > ]** key to move to the next menu option.

*Toggle between (ZERO ON) and (ZERO OFF) using the arrow keys and select desired mode with (ENT).*

**(r) Zero Set**

ZERO SET **ent**

If Zero Approach has been selected as ON, then Zero Set appears as the next "Set-Up" option.

SEL AXIS **>** **ent**

The example refers to a 3 Axis Lathe. For a DP8 Mill the axis would be **[ X ], [ Y ], [ Z ]**.

2.000 **X** **2** **ent**

The maximum envelope width is 2500mm (99").

2.500 **Z** **2** **.** **5** **ent**

0.000 **Z** **0** **ent**

Press the **[ > ]** key to move to the next menu option.

*Enter the Zero Set window by selecting the axis and entering the required value. Entering "0" omits the approach warning from that axis*

**(s) Position Pulse Output (Auxiliary Option only)**

POS OUT **ent**

ALL AXES **ent**

Options: OFF  
X AXIS  
Y AXIS  
Z AXIS  
ALL AXES

Scroll through available options using the arrow keys and select the desired axis with (ENT).

>

**IMPORTANT!**

This is only available with the optional auxiliary version and is detailed in Section 8.0

The Position Pulse Output function is only available on DSU's which have been fitted with the optional auxiliary output.

The function provides the operator with a way to control external devices such as relays or PLCs using the DP8. Setting Position Pulse Output to X AXIS, Y AXIS, Z AXIS or ALL AXES activates the feature for the selected axis.

**NOTE:** For the Lathe version, Y AXIS refers to the Z AXIS and the Z AXIS refers to the Z' AXIS.

Press the [ > ] key to move to the next menu option.

**(t) Position Set (Auxiliary Option only)**

POS SET **ent**

POSIT - 1 **>** **ent**

Options: POSIT-1 RESET  
POSIT-2 PULSE MS  
POSIT-3

Scroll through available settings using the arrow key, Load the relevant axes with the required data.

>

**IMPORTANT!**

This is only available with the optional auxiliary version and is detailed in Section 8.0

The Position Set function is only available on DSU's which have been fitted with the optional auxiliary output.

The function allows the operator to set parameters for each axis specified as output during the Position Pulse Output Set-Up.

Press the [ > ] key to move to the next menu option.

**(u) Reset to Original Factory Settings**

NORMAL **ent**

DEFAULT **>** **ent**

Options: DEFAULT  
QUIT NORMAL

Toggle between Default and Quit Normal using the arrow keys and select desired mode with [ENT]

>

**WARNING!**

Selecting DEFAULT will cancel all changes made during set-up. The DP8 will return to the original factory settings. Select QUIT NORMAL to leave the settings unchanged.

Normal returns all the Set-Up Options to the original factory settings (Except language setting).

**(v) Quit Set-Up**

QUIT **ent**

QUIT

Quit exits the Set-Up procedure and returns the DP8 to operational use.

Returns to normal operating mode.

# 5.0 STANDARD FUNCTIONS

## 5.1 Absolute/Incremental



### 5.1.1 Using Incremental

When the DP8 is set to incremental mode, it can be used to display each new position relative to the last position. This is also known as point-to-point use.

On setting to incremental you can reset each axis by pressing [ Xo ] [ Yo ] or [ Zo ].

As an alternative to resetting the axes, you can enter the coordinates relative to the current incremental position. If done in a negative sense, the operator can move to "0.000" which may save a great deal of machining time.

Each time you switch to incremental mode, the DP8 will display the position relative to the last reset position while in the incremental mode.

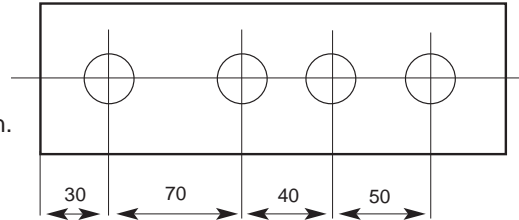

### 5.1.2 Using Absolute

When the DP8 is set to absolute mode it will display the position relative to an established datum point.

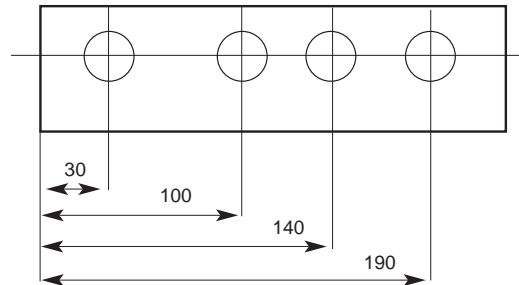







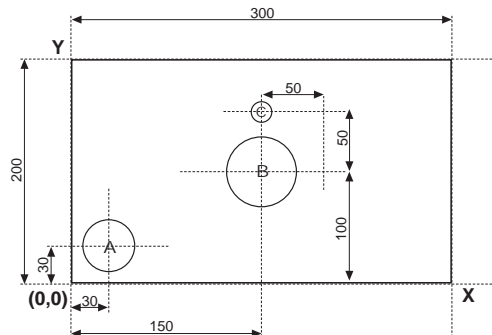

### 5.1.3 Establishing the Datum

When you reset the display in absolute mode, you are setting the current position of your machine as your datum point. All absolute positions will be measured relative to this datum.

To set the datum, position the machine at the point you intend to establish the datum and then reset any or all axes, while in the absolute mode.

The diagram below is used in the following example to show Absolute and Incremental modes.



<p>ABS </p> <p>0.0000 </p> <p>0.0000 </p>	<p>Set absolute zero at the lower left corner of the part</p>
<p>ABS</p> <p>30.000 X</p> <p>30.000 Y</p>	<p>Move to the first position in ABS (Hole A).</p>
<p>ABS</p> <p>150.000 X</p> <p>100.000 Y</p>	<p>Move to the second position in ABS (Hole B).</p>
<p>INC </p> <p>0.000 X </p> <p>0.000 Y </p>	<p>Switch to Incremental and Zero the display</p>
<p>INC </p> <p>0.000 X</p> <p>50.000 Y</p>	<p>Make an Incremental move to Hole C.</p>
<p>ABS </p> <p>150.000 X</p> <p>150.000 Y</p>	<p>Press the [ ABS/INC ] key to return the ABS mode.</p>

Using the DP8 display in the manner given above can save considerable time as the operator can avoid time consuming math calculations.

## 5.2 Centre Find

1/2

Centre Find halves the dimension displayed for any or all axes selected. You can use Centre Find in either absolute or incremental mode. The keystrokes are the same in either case.

1/2 AX ?

Locate to your first position (one edge of your workpiece) and zero the axis.

0.000

Locate/move to the second position (the other edge of the workpiece)

100.000

Use Centre Find to locate the centre point.

50.000

Move until display reads 0.000. At that point you will locate the center of the part

Xo

X

1/2

or

1/2

X

In the following example, Centre Find is being used on the X axis to find the centre point of a workpiece that is 100mm wide.

In either absolute mode or incremental mode, once you have used Centre Find you can locate to the centre point by moving until the display is at 0.000.

**NOTE:** If you are in absolute mode, remember that using centre find will set the datum to the centre point.

## 5.3 Digifind

ref

The DP8 comes equipped with Digifind, a feature unique to Newall digital readout products. Digifind eliminates the risk of losing your position and datum Set-Up. With Digifind, precise Set-Up of a workpiece is done only one time.

When the DP8 is powered on, it displays the position at power off, compensated for any movement of a Spherosyn transducer up to 0.2500" (6mm) and a Microsyn transducer up to 0.1000" (2.5mm) in either direction since the unit was last used. This applies whether the DP8 was switched off intentionally or accidentally, i.e., a power failure. If the machine has moved beyond 0.2500" (6mm) - Spherosyn [0.1000" (2.5mm) - Microsyn], Digifind allows a quick means to find the datum if lost. The DP8 will maintain the position for at least 30 days, the life of the battery back-up.

There are two ways to use Digifind:

1. In conjunction with a machine or workpiece marker;
2. To find the last datum (absolute zero).

### 5.3.1 Using a Machine or Workpiece Marker

A mark must be made on both a stationary part and moving part of the machine. The marks must be aligned and will serve as the machine "home" position. For example, the mark could be on the reader head and mill table, or a scribed line on the lathe way and a corresponding line on the carriage. The mark must be indelible, and it must allow the operator to move the machine to within a 0.2500" (6 mm) -Spherosyn [0.1000" (2.5mm) - Microsyn ] band around the mark at any time.

Alternatively, you can use a convenient reference point on the workpiece. This could be the datum position itself or any other convenient point. The point can be highlighted with a marker for ease. The reference point must allow the operator to position the machine to within a 0.2500" (6 mm) -Spherosyn [0.1000" (2.5mm) - Microsyn] band around the mark.

**FIND 0** **ref**  
**Options:** FIND 0  
 FIND REF  
 SET REF **<** **ent**

Once absolute zero has been established for the work-piece, move to the machine mark. The machine does not need to be positioned accurately, only within the band around the mark i.e. 6mm (0.2500") for Spherosyn and 2.5mm (0.1000") for Microsyn.

**SET REF**  
 Select SET REF by pressing the arrow right key. Select current position with [ENT]

Set the current position as the reference.

Repeat the procedures as desired for each axis.

**SEL. AXIS** **X**  
 Select the axis using the axis Pre-Set or Re-Set key. or **Xo**

**FIND 0** **ref**  
**Options:** FIND 0  
 FIND REF  
 SET REF **>**

If datum is lost at anytime, either because the machine had been moved with the power off, or the incorrect keys were selected, it is possible to "Find" the datum again.

Position the machine to within the 6mm (0.2500") band for Spherosyn and 2.5mm (0.1000") band for Microsyn. "Find" the reference.

**FIND REF** **ent**  
 Find reference position by pressing the arrow right key twice. Confirm with [ENT].

The position displayed indicates the correct distance to the absolute zero for that axis.

**SEL. AXIS** **X**  
 Select the axis using the axis Pre-Set or Re-Set key. or **Xo**

The original datum is reset.

### 5.3.2 Find Absolute Zero

As a fail-safe, Digifind can "find" the last datum or absolute zero set, i.e. the position the last time the [ Xo ], [ Yo ], [ Zo ], or [ Zo ] key was used.

**FIND 0** **ref**  
**SEL. AXIS** **ent**  
 Select FIND 0 by pressing [ENT].  
 Select the axis by using the axis Pre-Set or Re-Set key. **X**  
 or **Xo**

If datum is lost at anytime, either because the machine had been moved with the power off, or the incorrect keys were selected, it is possible to "Find" the datum again.

Position the machine to within 6mm (0.2500") for Spherosyn and 2.5mm (0.1000") for Microsyn, of the datum. "Find" the reference.

The original datum is reset.

## 5.4 Sub datums (SDM)

sdm sdm zero ins. del.

The DP8 can store up to 199 SDM (Sub-Datum) positions, or machining steps, in non-volatile memory. The positions remain in memory even if the power has been turned off.

Using SDM allows the operator to work to zero by calling up stored dimensions, instead of "working up" to print dimensions. This eliminates the need to constantly refer to the print, and reduces the possibility of scrapping parts due to mis-read dimensions. It also speeds up positioning because the operator works to zero.

The SDMs are stored as co-ordinates relative to the absolute datum position. If the absolute datum position changes, the SDMs will "shift" to the new datum.

SDMs provide the operator increased productivity in batch machining of parts. Once a repetitive sequence of co-ordinates is entered into SDM, the co-ordinates can be recalled at any time. The positions remain in memory until altered by the operator. Simply assign any SDM number 1 - 199 to each machining step. When machining, call up each step (SDM) number and work to zero.

SDMs also reduce time for tool changes by giving the operator a fast and accurate method of returning to locations for other operations.

SDMs also simplify machining parts with more than one datum point. The absolute zero or datum position is determined and set. Then the secondary datum positions are entered into SDM. Once the SDM co-ordinates are stored, the operator can display co-ordinates relative to the SDM, as well as to the absolute datum position.

SDMs are stored by using one of the following two methods:

### 5.4.1 Method 1 (Teach Mode)

Using this method, move the machine to the position to be stored as the SDM. Use this method to avoid entering print dimensions via the keypad. The operator "works up" to the dimensions on the print the first time. Each position is stored in SDM by pressing the Teach key [ SDM ZERO ], once an SDM number has been selected.

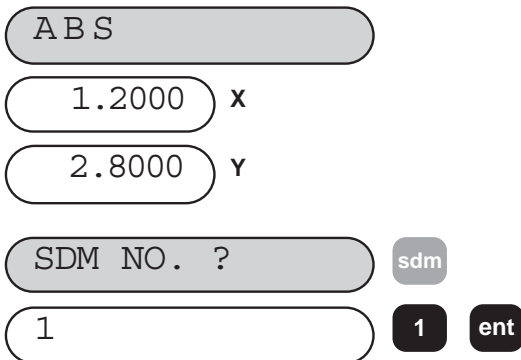

EXAMPLE:  
Keystrokes for entering the following part dimension into SDM are shown.

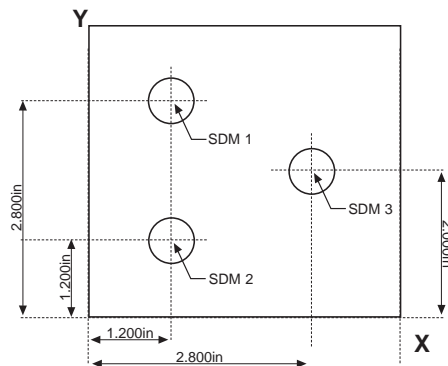

SDM 1 

0.0000 X

0.0000 Y

Establish absolute zero at the lower corner of the part. Move to the first position and change to SDM 1. Press [SDM ZERO]. This will store the current machine position in the selected SDM and will zero all axes. The current position is now stored as SDM 1.

ABS 



1.2000 X

1.2000 Y

The next move is Absolute. Select the [ABS/INC] key and move to the position. Select a new SDM number and store the position with [SDM ZERO].

**IMPORTANT:**  
The dimensions in the display may change after you select the SDM number even though the machine has not moved. The numbers are the last dimensions stored in that particular SDM and should be ignored. Pressing [SDM ZERO] will store the actual current position in the SDM block.



2  

SDM 2 

0.0000 X

0.0000 Y

SDM 3  

Repeat this procedure to store SDM #3 into memory.

Scroll to the next SDM by using the arrow keys. Alternatively, use the [SDM] key to select a new SDM.

SDM 3 

0.0000

0.0000 

**NOTE:** If the next move is Incremental, move to the position, select a new SDM number, and store the position with [SDM ZERO]

To exit SDM function, select [ABS/INC].

## 5.4.2 Method 2 (Manual Mode)

In this example, known SDM co-ordinates are entered via the keypad without moving the machine. SDM co-ordinates must be entered relative to the absolute datum position. In other words each axis should be set to zero prior to programming sub-datums

SDM NO. ? sdm

1 1 ent

Select the first SDM number using the [SDM] or arrow keys.

SDM 1

1.2000 X 1 . 2 sdm

2.8000 Y 2 . 8 sdm

Select the desired AXIS, enter the dimension and confirm with SDM.

Scroll through the next SDM by using the arrow keys. Alternatively, use the [SDM] key to select a new SDM. Enter the new coordinates via the keypad.



**NOTE:** The axis displays will change to show the current position relative to the SDM.

Repeat procedure for SDM2 and SDM 3.



To exit SDM function, select ABS/INC

**EXAMPLE:**  
Keystrokes for entering the following part dimension into SDM are shown.

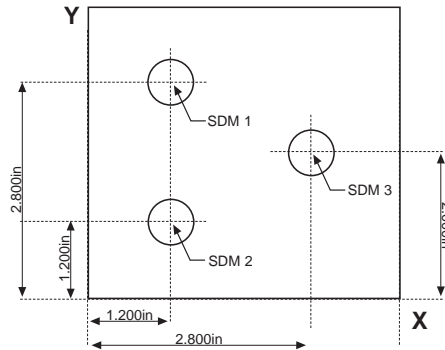

## 5.4.3 Job Numbers

This function enables a group of sub datums to be identified by a number at the beginning of the group, and an end marker at the end of the group.

Once a series of sub datums has been entered it is possible to enter the Job Number and End Marker. From a selected Sub Datum proceed as follows in the example below:

### (a) To insert a Job Number

SDM NO? sdm

10 1 0

SDM 10 ent

Select the first Sub Datum in the sequence to be grouped e.g. SDM10

INS SDM ins.

Press INS key.

INS JOB? >

ent

Press the arrow key to display Insert Job. Confirm with [ENT].

JOB NO?

Job numbers can be entered up to 4 digits eg: 1234

Enter a job number.  
Confirm with Enter

1 2 3 4 ent

JOB 1234

All the higher numbered Sub Datums are shifted by one place. i.e. The sub datum figures from SDM10 become SDM11, SDM11 become SDM12 etc.

X

**NOTE:** If SDM199 contains data, then that data will be lost

Y

The Sub Datum containing the job number has no axes data.

Z

The message screen displays 'JOB 1234' and the axes displays become blank



Pressing [ ABS/INC ] will exit the function.

**(b) To add a Job End statement**

The procedure is similar to entering a Job Number, except as follows:

SDM NO? sdm

15 1 5

SDM 15 ent

Select the Sub Datum immediately following the last Sub Datum in the sequence to be grouped e.g. SDM15

INS SDM ins.

Press INS key. Use the arrow keys to scroll through the message screen to 'Insert Job' < >

JOB END ent

After 'INS END' is displayed pressing the ENT key will inset the statement



All the higher numbered Sub Datums are shifted by one place. i.e. The Sub Datum figures from SDM15 become SDM16, SDM16 become SDM17 etc.

**NOTE:** If SDM 199 contains data, then that data will be lost.

The Sub Datum containing the job end marker has no axes data.

Pressing [ ABS/INC ] will exit the function.

**(c) Searching for a Job Number**

The procedure is similar to finding a Sub Datum, except as follows:

SDM NO? sdm

Enter the Sub Datum function by pressing the SDM key. The message screen prompts for the Sub Datum number.

Pressing the right arrow key changes the message screen to 'JOB NO?' >

## Standard Functions

JOB NO?

Enter the required job number. Confirm with Enter

1 2 3 4 ent

JOB 1234

1234?

Alternatively, the right arrow key will display all the available job numbers.



Pressing the (ENT) key will make the selected job number active.



The Sub Datums are searched to find the Job Number. If the number is not found the first number will be displayed.

Pressing [ ABS/INC ] at any time will exit the function.

### 5.4.4 Editing Sub Datums and Job Numbers

To edit the Sub Datums and Job Numbers the [ INS ] and [ DEL ] keys are used. From a selected Sub Datum proceed as follows:

#### (a) To delete a Sub Datum

SDM NO?

sdm

As an example, select the Sub Datum to be deleted eg. SDM 20

2 0

20

ent

SDM 20

DEL SDM?

del.

Pressing the ( DEL ) key causes the message screen to ask for confirmation if the Sub Datum is to be deleted.

All the higher numbered Sub-Datums are shifted down one place. i.e. The Sub Datum figures from SDM21 becomes the new SDM20, SDM22 becomes SDM21 etc.

Pressing the (ENT) key confirms the deletion.



NOTE: Pressing CE clears the selection, and the SDM is retained.



#### (b) To delete a Job Number

Follow the above sequence except scroll the message screen, using the arrow keys, to display the Job Number to be deleted instead of the Sub Datum number.

(c) To insert a SubDatum

The process for inserting a Sub Datum is similar to inserting a Job Number (Section 5.4.3 (a)) except when the Sub Datum is selected do not press [ > ] to access the Insert Job mode 'INS JOB?'.  
 The process for inserting a Sub Datum is similar to inserting a Job Number (Section 5.4.3 (a)) except when the Sub Datum is selected do not press [ > ] to access the Insert Job mode 'INS JOB?'.

SDM NO? 

Select the Sub Datum Function [ **SDM** ].

5 

SDM 5 

INS SDM? 

Select [ **INS** ] to enter insert mode.

SDM 5 

Again, all the higher numbered Sub Datums will be shifted one place up and any stored data in SDM 199 will be lost.

Proceed to enter the sub datum as described in Sections 5.4.1 or 5.4.2



Pressing [ **ABS/INC** ] will exit the function.

### 5.5 Inch/Millimetres



To change between display in millimetres and in inches, press [ **IN/MM** ]. The displays will be converted instantly. A light beside the key reminds you which measurement you are using.

Selecting inch or millimetre display applies to all dimensions. For example, if you are in millimetre display, whenever you enter dimensions you should also use millimeters.

When you switch on the DP8, it will display in the same unit of measurement that you set when you last used the unit.

### 5.6 Datahold (Display Off)



Datahold allows you to disable the DP8 display/keypad but retain power to the measurement transducers and memory circuits. You can use datahold to prevent unauthorised or accidental use of the DP8 whilst unattended.

To select datahold, press  key.

To return to normal use, press the  key.

**NOTE:** If the [ **ABS/INC** ] key is pressed prior to the second  the DP8 will go into Set-Up mode.

### 5.7 Zero Approach

Zero approach is an indicator to the operator that the machine position is approaching a user definable position on the component. Section 3.3 (r) details the procedure for setting the approach warning window.

When ever any axis display is less than (or equal to) the defined window, then a flashing '0' appears at the left of that axis display. As the axis moves closer to the zero position the flash rate increases. When the axis is closer than 0.05mm (0.002") to zero the "0" stops flashing and remains lit.

## 6.0 MILL FUNCTIONS

### 6.1 PCD / Bolt Hole Circle



The DP8 Mill calculates positions for a series of equally spaced holes around the circumference of a circle or an arc. The message display prompts the user for various parameters it needs to do the calculations. Once the DP8 Mill completes the calculations, the axis displays show the distance to each hole. The operator works to Zero for each hole location.

To access the PCD function press the  key.

PCD - XY



**Options:**  
PCD - XY  
PCD - XZ  
PCD - YZ



Scroll through available options using the arrow key and select desired plane with ENT.



CENTRE? 

50.0000 **X** **5** **0** **ent**

50.0000 **Z** **5** **0** **ent**

**>**

DIA?

40.0000 **4** **0** **ent**

**>**

NO HOLES

3 **3** **ent**

**>**

ST ANG?

90.000 **9** **0** **ent**

**>**

END ANG?

270.000 **2** **7** **0** **ent**

**>**

HOLE 1

-50.000

-70.000

*Position the X and Y axes until both displays read Zero. This is the first hole location.*

HOLE 2 **<** **>**

**EXAMPLE:**

The keystrokes for entering the following bolt hole circle are shown. X and Y axes are assumed at Absolute Zero.

**NOTE:** The 2 axes mill operations are similar to the 3 axes version except that the PCD is not plane selectable.

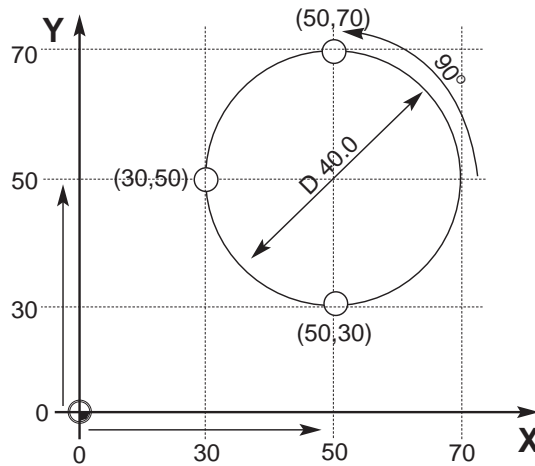

The bolt pattern will be calculated from the 3 o'clock position, counter-clockwise. The starting angle is the angle from the 3 o'clock position to the first hole. Enter the angle as a negative value if it is given as clockwise from 3 o'clock.

The ending angle is calculated from the 3 o'clock position counter-clockwise to the last hole. If the pattern is a complete circle, enter the same ending angle as starting angle.

**NOTE:**

The numbers appear as negative numbers because the operator works to 0,0. According to the above drawing, the first hole is in a positive position for both X and Y. Therefore, the display will count up to zero when the axes are moved. If these numbers do not appear, exit the PCD function and check the axes readings in X and Y. You will find that the Hole 1 dimensions are the sum of the absolute positions plus the calculated positions. The hole locations will always reference 0,0.

Use the arrow keys to display co-ordinates for subsequent holes in the routine. Work to zero for each hole location.



## 6.2 Arc Contouring



The DP8 calculates positions for rough machining an arc or radius. The message display prompts the user for various parameters needed to do the calculations. Once the calculations are complete, the axis displays show the co-ordinates, which are point-to-point positions along the arc. The operator moves to Zero for each point position.



It is possible to machine along the inside or outside of the arc. Arc Contouring can be used in three planes: XY, XZ or YZ. The vertical planes (XZ, YZ) are only available if using a 3-axes DP8 Mill.



ARC -- XY 

Options: ARC - XY   
 ARC - XZ  
 ARC - YZ 

*Scroll through available options using the arrow key and select desired plane with [ENT].*

CENTRE ?



2.3700  2 . 3 7 



1.4900  1 . 4 9 

RADIUS ?



4.0000  



ST. PT? 

1.3200  1 . 3 2 

5.3700  5 . 3 7 

END. PT? 

6.2200  6 . 2 2 

2.5100  2 . 5 1 

TOOL DIA 

0.5000  5 

EXAMPLE:  
 The keystrokes for entering the following arc are shown.

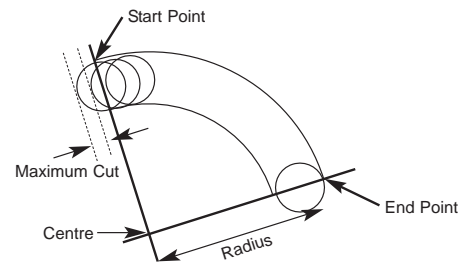

Centre:	X2.370"	Y1.490"
Radius:	4.0"	
Start Point:	X1.320"	Y5.370"
End Point:	X6.220"	Y2.510"
Tool Diameter:	0.5"	
Internal/External:	Internal (RAD-TOOL)	
Maximum Cut:	0.1"	



The ARC function assumes an arc of 180° or less. For a 180° arc, the routine will calculate the arc in a counter-clockwise direction, assuming standard XYZ movement.

**IMPORTANT!**  
 If the parameters entered in START POINT and END POINT are inconsistent, the CENTER and RADIUS figures override the inconsistent parameters.



RAD - TOOL 

Options: RAD - TOOL  
RAD + TOOL  

The RADIUS + TOOL calculates a toolpath which is compensated to the outside of the Arc. RADIUS - TOOL calculates a toolpath which is compensated to the inside of the Arc.

Scroll through available options using the arrow key and select internal or external with (ENT).

MAX CUT? 

0.1000   

MAXIMUM CUT refers to the distance between machining points. The smaller the increment, the smoother the arc and the more points calculated. The larger the increment, the rougher the arc and the fewer points calculated.

PT 1 

-1.3904 

-5.1098 

The DP8 displays the distance to Point 1. The example assumes the operator is at absolute zero. If not, the numbers displayed will be the calculated axes values, plus the values of the current X, Y position relative to 0,0.

PT 65 

-5.9950 

-2.4504 

Use the arrow key to display co-ordinates for the last point in the arc. This also displays the number of points to be worked in the arc.

PT 2  

Use the arrow keys to display sequential co-ordinates for each point along the arc. Move the work to Zero at each point.

## 6.3 Line Hole Function

Line Hole Function can be accessed in either the Absolute, Incremental or Sub-Datum modes.

To enter the Line Hole function press the  key.

Three axes versions will display the message LINE - XY, or XZ or YZ.

LINE 

LINE -XY 

Options: LINE - XY  
LINE - XZ  
LINE - YZ 

**NOTE:** Two axes versions will not offer the axes selection and will directly prompt 'START'. The rest of the sequence is identical.

Scroll through available options using the arrow key and select your option with (ENT).

# Mill Functions

START

10.000 X 1 0 ent

10.000 Y 1 0 ent

LENGTH >

30.000 3 0 ent

NO. HOLES >

4 4 ent

ANGLE? >

45.000 4 5 ent

HOLE 1 >

-10.000

-10.000

Position the X and Y axes until both displays read Zero. This is the first hole location

HOLE 2 < >

EXAMPLE:  
The keystrokes for entering the following Line Holes are shown. X and Y axes are assumed at Absolute Zero.

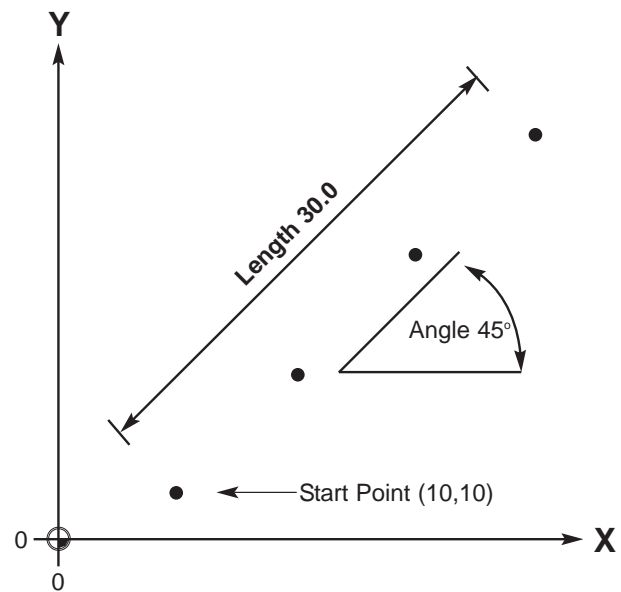

NOTE: Length is the total length of the line hole sequence, not the distance between adjacent holes.

## 6.4 Polar Co-ordinates

The Polar co-ordinate function enables the operator to convert the displayed data from the conventional Cartesian co-ordinates (X,Y,Z) to Polar (Length + Angle) co-ordinates for any plane XY, XZ or YZ.

Pressing the  switches between the two displays.

The  can be selected from the Absolute, Incremental or Sub Datum modes.

-

20.0000

15.0000

Assume the adjacent Cartesian (x,y,z) co-ordinates are displayed

POLAR- XY



Options: POLAR-XY  
POLAR-XZ  
POLAR-YZ



Press the polar key to switch to Polar mode.  
Use the arrow keys to scroll between the available planes.

Note: Only (X,Y) is available on the 2 axis version.

Pressing the [ POLAR ] key converts the display from Cartesian into Polar mode.

EXAMPLE:  
Diagram showing both Cartesian and Polar Plot

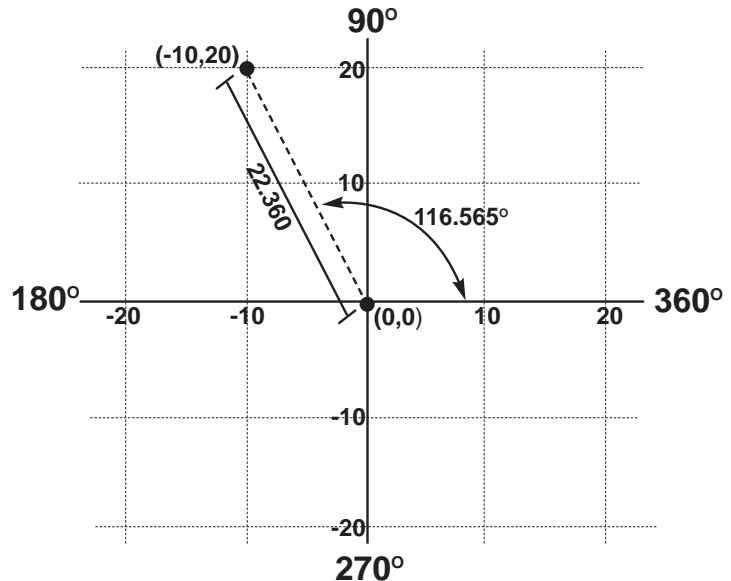

P 22.360

A

-15.000

The letter P appears in the left most display segment. This is the argument or length of the vector. See the diagram for clarification.

The letter A appears in the second axis display. This refers to the angle of the co-ordinates. The angle is displayed to three decimal places.

As the plane X,Y was selected the Z display remains unchanged.



Pressing the Polar key again returns the display to Cartesian co-ordinates.

**NOTE:** Pressing the [ Xo ] key in Polar mode will reset the argument to zero, i.e. X and Y both zero in cartesian co-ordinates.

# 7.0 LATHE FUNCTIONS

## 7.1 Tool Offsets



The Tool Offset function allows the operator to enter and store offsets for a range of tools. This enables the operator to change tools without resetting absolute zero or datum. Using tool offsets insures that diameter and length measurements will remain consistent after tool changes. This speeds up tool changes and increases productivity as it eliminates the need for the operator to stop and manually measure the diameter.

The number of Tool Offsets available is 99. This large number allows tools to be grouped where more than one set is used. For convenience, it is highly recommended that Tools are physically marked with their corresponding Tool number. Also, it is recommended that an indexable style tool post be used to ensure that the tools are always in the same position in the tool post after the offsets are programmed.

The Tool Offset function involves two separate and distinct operations:

1. Entering Tool Offsets with the **[TOOL SET]** key
2. Using Tool Offsets with the **[TOOL]** key

The two separate functions insures against accidental loss or reprogramming of a tool offset dimension while in use.





### (a) Entering Tool Offsets

ABS 

In order to enter Tool Offsets correctly, the display must be in ABS mode.



TOOL NO ?   
 1  

*Press Tool Set key and select tool 1 by pressing 1 on the keypad. Confirm option with ENT.*

SET T 1  
 45.300     

*To datum the X axis take a skim cut of the component (or touch the diameter). Measure the diameter with a suitable gauge e.g.45.3mm* 

**NOTE:** The X axis must not be moved off of the part after taking the skim cut. Enter the diameter as shown (or radius if the X axis is set to RAD)

0.000   

*To datum the Z axis take a facing cut with tool number 1. Do not move the tool away from the face and enter the Zero value*

The [ Xo ] and [ Zo ] keys are inactive in tool set mode.

**IMPORTANT!**  
 The first tool entered in Tool Offsets is always considered to be the Reference Tool. All other tools entered are offset in relation to the difference in length and width as compared to Tool 1.

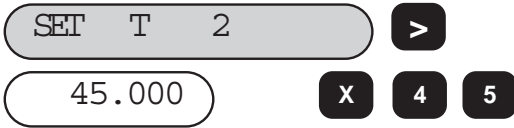

To set the X axis take a skim cut of the component (or touch the diameter). Measure the diameter with a suitable gauge e.g. 45.0mm Enter the diameter as shown.

To set subsequent tools use the arrow key to scroll to the next tool number. Move the tool post to the next tool, or physically insert Tool 2

It is not necessary to have sequential tool numbers, for example tools 1,3,5,7 etc are viable options.

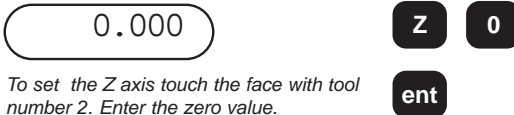

To set the Z axis touch the face with tool number 2. Enter the zero value.

To exit press the [TOOL SET] key.

**(b) Using Tool Offsets**

It is possible to access the Tool Offset function from the Absolute, Incremental or Sub Datum modes.

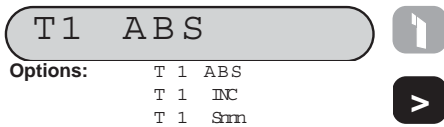

Pressing the [TOOL USE] key enters the tool use mode and displays T1 ABS, T1 INC or T1 Snnn (where nnn refers to the sub datum number)

As Tool 1 has zero offsets the axes display will not change.

**NOTE:** When in 'Tool Use' mode the [ ABS/INC ] and [ SDM ] work in the normal way.

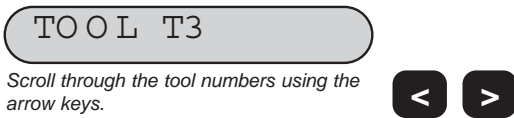

Scroll through the tool numbers using the arrow keys.

The arrow keys scroll the display forward (or backward) through the stored tools.

OR

Key in the desired tool number using the keypad and select option with ENT.

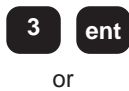

The tool number can be entered directly enabling the operator to directly access the required tool offset. e.g. Tool 3 as shown.



For each tool, the offsets are added to the displayed figures. Before machining a new part, select a tool, take a diameter cut with that tool, measure the diameter and enter the figure in the X display. For the Z, take a facing cut at a known dimension and enter the value in the Z display. Other tools will then be referenced to the same datum.



Pressing the [TOOL USE] key again exits the function.

## (c) Editing Tool Offsets

TL ABS



If a tool is worn or replaced then that tool offset must be reset.

Before editing a tool it is necessary to ensure the datums are correctly set.

Press the [TOOL USE] key and select tool number 1 (Unless this tool is to be edited). Datum the axes as described in (b) using Tool Off-Sets. For the purpose of editing, make the Z dimension zero.



Press the [TOOL USE] key to exit tool use mode

TOOL NO ?



Enter edit by pressing the [TOOL SET] key.

TB ABS



To enter the revised tool offsets take a skim cut of the outer diameter with the selected tool. Without moving the tool off of the part, measure the diameter or radius and enter the value in the X axis display. For the Z axis, touch the face and enter '0' in the Z axis display.

**NOTE:** If tool 1 needs to be edited, the procedure is the same except the axes should be datumed using another tool.



Press the [TOOL SET] key to exit the edit mode.

## 7.2 Taper Function



The taper function shows the angular displacement of the displayed (X,Z) position. The function can be entered from Absolute, Incremental or Sub Datum mode.

34.788



The message screen will display the angle of the X and Z co-ordinates relative to the X and Z datums.

32.992 X

47.490 Z

Press Taper key and enter Taper mode.



Pressing the [ TAPER ] key returns to the normal display.

### 7.3 Summing

1+1

The summing function allows the sum of two selected axes to be displayed. The axes are selected in Set-Up see section 3.2. Summing is available on the 3-Axis version only.

100.000 X  
 1234.000 Z  
 50.000 Z'

In the following example it assumes that the bed (Z) and compound (Z') are the selected axes.

Z + Z' > Z 1+1  
 100.000 X  
 1284.000 Z  
 50.000 Z'

Press the Summing key [ 1+1 ] to select the Summing function. The selection of the summed axes is made in Set-Up (Refer to Section 3.2).

The message screen displays Z+Z'>Z, and the Z display shows the sum of the two axes.

ABS 1+1  
 100.000 X  
 1234.000 Z  
 50.000 Z'

Pressing the [ 1+1 ] key returns to the original (non summed) axes display.

**NOTE:** Axis displays may be zeroed or loaded with a value in the summed mode. The underlying X or Z values are altered to suit.

### 7.4 Vectoring

1+1

When a Lathe is fitted with a scale on the compound, vectoring provides a true reading of the tool path when it is angled at any position from 0° - 90° relative to the part. Vectoring is calculated using the formulas  $(Z + Z\cos\theta)$  and  $(X + Z\sin\theta)$  where Z represents the compound scale reading.

Vectoring has to be initially selected in the Set-Up routine. (Refer to Section 3.2)

10.000 X  
 10.000 Z  
 1.000 Z'

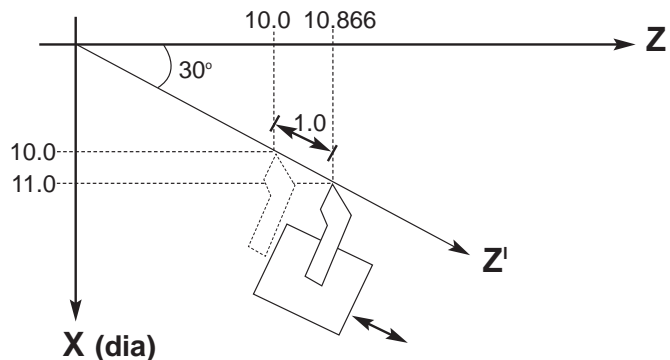

# Lathe Functions

ANGLE? 1+1

X

30.000 Z

Z'

3 0 ent

Press the [ 1+1 ] key to select the Vectoring function.

The message screen display prompts the operator to enter the angle of the tool axis.

The Z axis displays the last entered angle. Change the angle if necessary and enter the figure. Press [ ENT ]

Z<sup>I</sup> VEC → X.Z

11.000 X

10.866 Z

0.000 Z'

Press [ ENT ] (or [ 1+1 ] again) to accept the angle.

**NOTE:** The X axis (Cross axis) is set to read DIA in this example

10.000 X

10.000 Z

1.000 Z'

1+1

Pressing the [ 1+1 ] icon returns to the original (non vectored) axes display.

**NOTE:** As for summing (Section 7.3), axis displays can be zeroed or loaded with a value in the vectored mode.

# 8.0 AUXILIARY OUTPUT OPTION

Figure 8.1 shows the pin functions of the auxiliary connector.

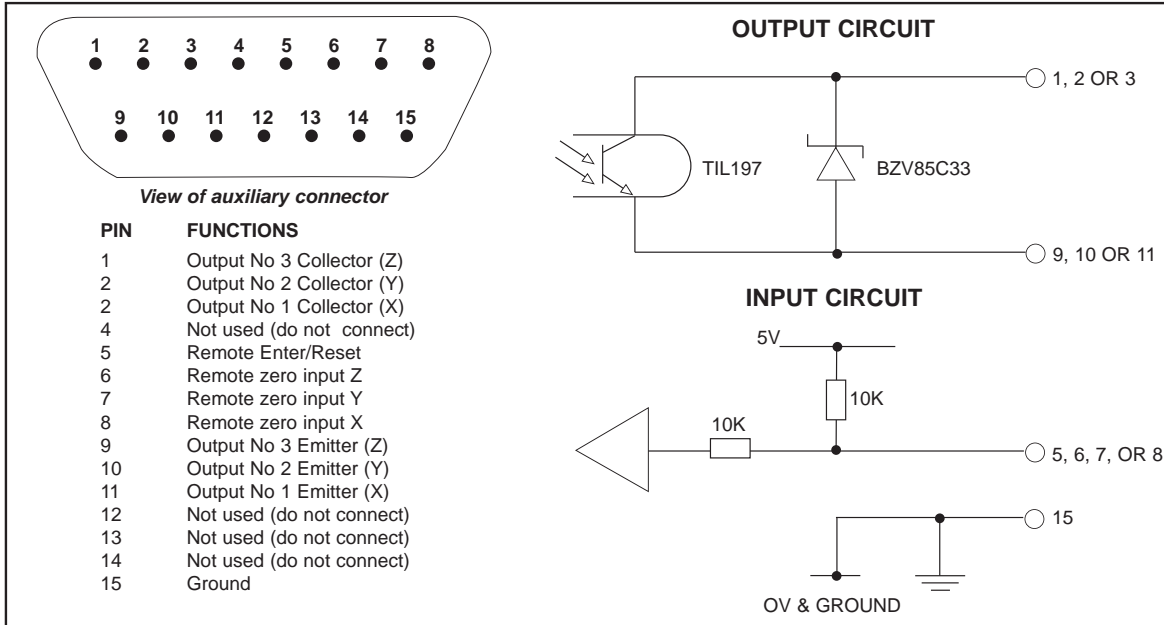

Figure 8.1 Auxiliary Connector

## 8.1 Position Pulse Output

### 8.11 Purpose

The Position Pulse Output function on the DP8 provides a means by which external devices such as relays or programmable logic controllers (PLC's) can be used to control a machine from the DP8. Only low voltage connections may be made to the auxiliary input/output of the DP8.

### 8.12 Outputs

There are three optically isolated outputs for this function. These are transistor outputs with both the collectors and emitters uncommitted, i.e. equivalent to voltage free contacts. The transistors are normally in the ON state (normally closed contacts) and change to the OFF state when active. The rating of the transistors is:-

$$V_c \text{ MAX} = 30V$$

$$I_c \text{ MAX} = 40mA$$

Figure 8.2 shows an example of use with relays

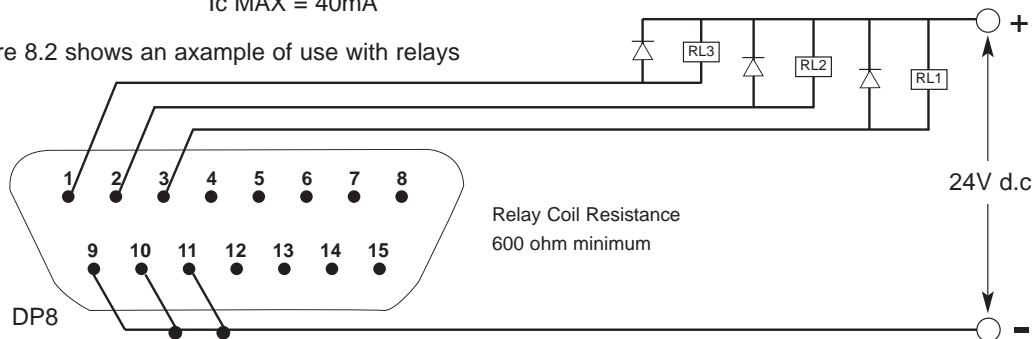

Figure 8.2 Connection to Output Relays (example)

## Auxiliary Output Option

### 8.13 Inputs

There is one input which may be used to reset the position pulse output function. This input is grounded to cause a reset. e.g. a switch or relay contact may be used.

### 8.14 Operation

There are two modes of operation; single axis or all axis.

#### (a) Single Axis Operation

Each one of the three outputs corresponds to a set position, position 1, 2 or 3, on one axis only. As that axis passes through each of the set positions then the corresponding output will change from its normally ON state to OFF. The direction of travel must be in the negative direction and each output will change just once and stay OFF until reset. The outputs may be reset in one of three different ways;

- i) by pressing the **[ENT]** key
- ii) by means of the external input
- iii) by returning the axis past a preset "reset" position.

Figure 8.3 illustrates single axis operation.

This mode of operation enables the DP8 to be easily connected to relays or a PLC for control on one axis.

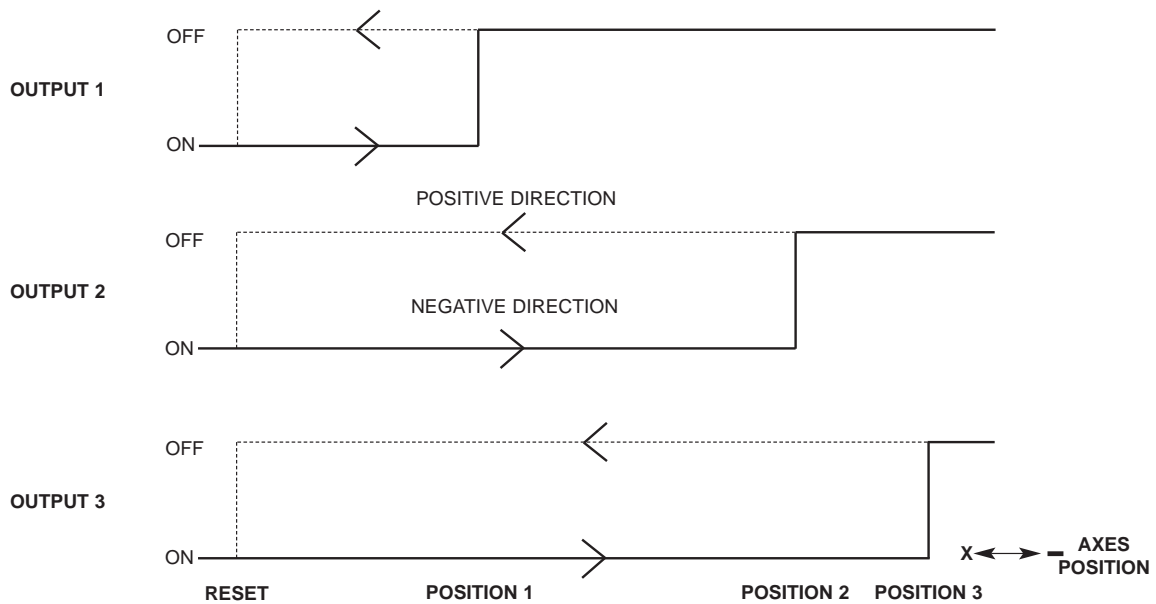

**Figure 8.3 Pulse Position Output (Single Axis)**

#### (b) All Axis Operation

Each of the three outputs corresponds to one axis only. Three positions together with a reset position can be set for each axis. As an axis passes through the first two set positions a pulse will occur on the output for that axis. As the third position is reached then the output will change state to OFF and stay in that condition until a reset occurs. The reset methods are as for single axis operation. As with single axis operation the direction of travel must be negative, therefore the first and second positions must be set at more positive values than the third. Figure 8.4 illustrates all axis operation.

The width of the output pulses may be set from 2ms up to 120ms.

In this mode of operation the DP8 may be easily connected to a PLC for control of one, two or three axes.

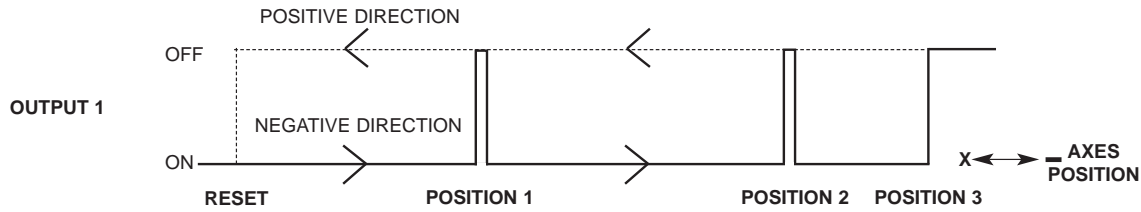

**Figure 8.4 Pulse Position Output (All Axes - shown for X axis only)**

### (C) Set-Up

The Position Pulse Output parameters are set through “Set-Up” (Refer to Section 3.3). Select “POS OUT” from the menu. This will give a sub-menu with the following choices:-

- OFF Select for no output pulses
- X Axis Select for single axis operation on X
- Y Axis Select for single axis operation on Y (Note: For the lathe version Y axis refers to Z Axis)
- Z Axis Select for single axis operation on Z (Note: For the lathe version Z axis refers to Z' Axis)
- All Axes Select for all axis operation

Use the arrow keys until the desired mode is displayed, then press ENT. If the Position Pulse Output is not to be used select OFF.

Also in the main menu is the item POS SET. Selecting this gives another sub-menu:-

- POSIT-1 Set 1st position(s) on one or all axes
- POSIT-2 Set 2nd position(s) on one or all axes
- POSIT-3 Set 3rd position(s) on one or all axes
- RESET Reset position(s) on one or all axes
- PULSE MS Set pulse width in ms (one value only)

The arrow keys will move you through these parameters displaying the current settings. To alter a setting, press the appropriate axis key and enter the new value. e.g. if “ALL AXIS” operation has previously been selected, then the keystrokes might be:

POSIT-1

100.000	X	1	0	0	ent
50.000	Y		5	0	ent
350.000	Z	3	5	0	ent

Set position 1 for each axis using the axis keys and keypad. Confirm each axis with (ENT).



Use the right arrow key to move to next setting.

**WARNING:**  
For correct operation, the RESET position must be more positive than Position 1, which must be more positive than Position 2, which must be more positive than Position 3.

POSIT-2

35.000	X		3	5	ent
10.000	Y		1	0	ent
140.000	Z	1	4	0	ent

Set position 2 for each axis using the axis keys and keypad. Confirm each axis with (ENT).



Use the right arrow key to move to next setting.

## Auxiliary Output Option

POSIT-3

30.000 X 3 0 ent

- 5.000 Y - 5 ent

110.000 Z 1 1 0 ent

Set position 3 for each axis using the axis keys and keypad. Confirm each axis with (ENT).

> Use the right arrow key to move to next setting.

RESET

750.000 X 7 5 0 ent

175.000 Y 1 7 5 ent

505.000 Z 5 0 5 ent

Set Reset position for each axis using the axis keys and keypad. Confirm each axis with (ENT).

> Use the right arrow key to move to next setting.

PULSE MS

25.000 Y 2 5 0 ent

Set the width of the output pulse using the Y axis key and keypad. Confirm with (ENT.)

> Use the right arrow key to move to next setting.

POS SET ent

Press to return to the main menu.

## 8.2 Remote Zero and Enter Inputs

### 8.21 Remote Zero

Three inputs are provided for the remote zero function, one for each axis X, Y or Z. When one of these inputs is grounded, e.g. by a switch or relay contact, then the respective axis display will zero. This action is equivalent to pressing the [Xo], [Yo] or [Zo] keys.

### 8.22 Remote Enter

One input is provided for a remote enter. This input can be used as a remote [ENT] key. For example, it may be required that the X axis be set to 25.0 whilst making fine adjustments at some distance away from the DP8. Press [X][2][5] on the DP8 keypad and, when ready, press the remote [ENT] switch.

Figure 8.5 shows an example of a connection to remote switches.

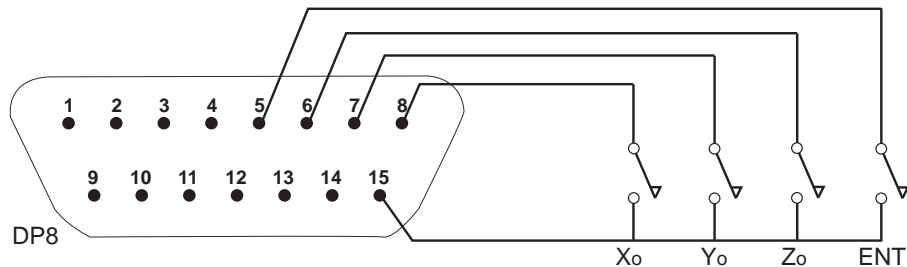

Figure 8.5 Connection to Remote Zero and Enter Switches

## 9.0 TROUBLESHOOTING

Symptom	Solutions
1 Nothing happens when the unit is switched on. Even the switch lamp is off.	<p>Check that the unit is correctly connected to a working power source. Check the power lead is not damaged.</p> <p>Check the selector switch on the DP8 DSU is set to accept the correct power supply voltage.</p> <p>Check the fuse. Note that if the fuse has blown, this suggests a fault with the power source which must be corrected before the fuse is replaced. (See Section 2.2)</p>
2 The switch lamp is on but nothing happens	Check the cable and connections between the DSU and Display/Keypad.
3 When the unit is switched on the displays are frozen.	<p>This suggests that voltage of the power is too low.</p> <p>Check that the power source is within the limits accepted by the unit. (See Section 2.2)</p>
4 The displays work, but reset from time to time without the keys being pressed.	<p>This suggests either that the voltage of the power source is too low, or that the power source has an intermittent fault.</p> <p>Check the power source as above.</p> <p>Check that all connections are sound.</p>
5 The displays work, but give erratic readings, the last digit jitters or the measurements jump to new figures unexpectedly.	This suggests that there is a poor earth (ground) connection. Both the DP8 unit itself, and the machine on which it is installed, must have proper earth (ground) connections. (See Section 2.1) See also solutions to 6.
6 "SIG FAIL" appears in the display.	<p>Check that the transducer connection is good.</p> <p>Check that there is no damage to the connectors or to the transducer lead. If only one axis is displaying this message, connect the transducer from a working axis into the faulty axis. If the same message appears, the fault is likely to be in the DP8 unit and you should contact your local dealer. N.B. The unit must be switched off then on again to remove the "SIG FAIL" message.</p>
7 The unit will not respond to keys.	Switch the unit off and back on. Check the cable and connections between the DSU and Display/Keypad.

## 10.0 CLEANING

Disconnect the DSU from the power supply before cleaning.

It is recommended that the DSU and Display/Keypad be wiped over with a lint-free cloth with a non corrosive, non abrasive cleaning fluid.

Do not use compressed air.

---

# NEWALL MEASUREMENT SYSTEMS LTD

---

## HEAD OFFICE

### **Newall Measurement Systems Ltd.**

Technology Gateway, Cornwall Road

South Wigston

Leicester LE18 4XH

United Kingdom

Telephone: +44 (0)116 264 2730

Facsimile: +44 (0)116 264 2731

Email: [sales@newall.co.uk](mailto:sales@newall.co.uk)

Web: [www.newall.co.uk](http://www.newall.co.uk)

---

### **Newall Electronics, Inc.**

1778 Dividend Drive

Columbus, OH 43228

Telephone: +1 614 771 0213

Toll Free: 800.229.4376

Facsimile: +1 614 771 0219

Email: [sales@newall.com](mailto:sales@newall.com)

Web: [www.newall.com](http://www.newall.com)

### **Newall France SARL**

63 Rue Victor Hugo

F-59200, Tourcoing

FRANCE

Telephone: +33 (0) 3 20 01 03 13

Facsimile: +33 (0) 3 20 26 13 41

Email: [sales@newall.fr](mailto:sales@newall.fr)

### **Newall Deutschland**

Postfach 20

72117 Ammerbuch

GERMANY

Telefon: +49 (0) 7073 302908

Fax: +49 (0) 7073 302963

Email: [manfred.friebe.newall.co.uk](mailto:manfred.friebe.newall.co.uk)